

**MAX ROOF BOX LOAD RATING: 75 KG**

**PLEASE REFER TO VEHICLE MANUFACTURER SPECIFICATIONS FOR MAX ROOF LOAD RATING  
(TOTAL LOAD EQUALS WEIGHT OF BARS + ROOF BOX + CARGO)**

## FIRST TIME INSTALLATION

- Please read instructions carefully before installation.
- Check the contents of kit. Contact your YAKIMA dealer if any parts appear missing or damaged.
- Clean your vehicle roof prior to fitting the EasyTrip.
- Place these instructions in the vehicle's glove box after installation is complete.

**3 YEAR WARRANTY**

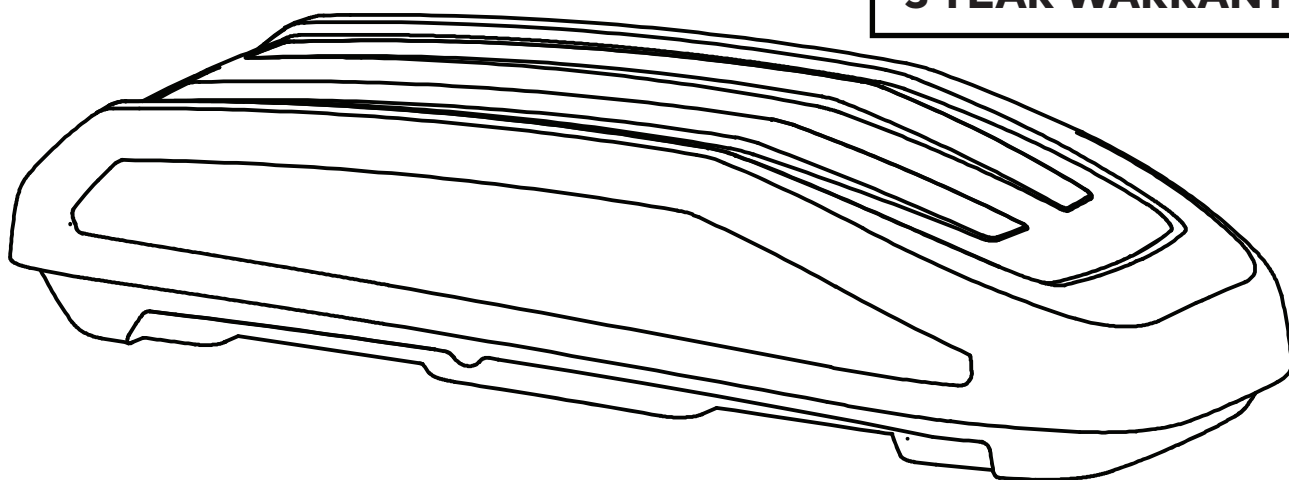

## KIT CONTENTS

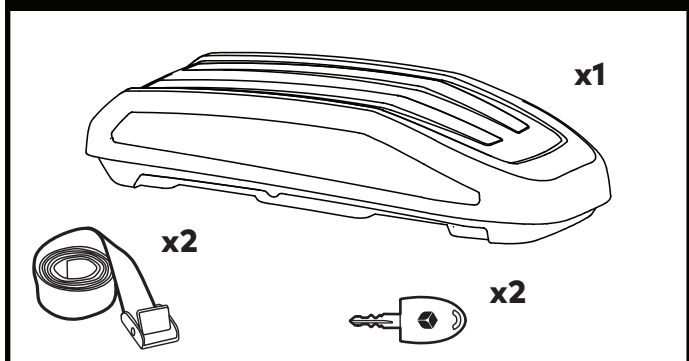

	EasyTrip 400 L	EasyTrip 470 L	EasyTrip 550 L
	L 165 cm W 90 cm H 41 cm	L 186 cm W 90 cm H 43 cm	L 206 cm W 90 cm H 47 cm
	13.8 kg	16 kg	20 kg
	MAX 75 kg	MAX 75 kg	MAX 75 kg

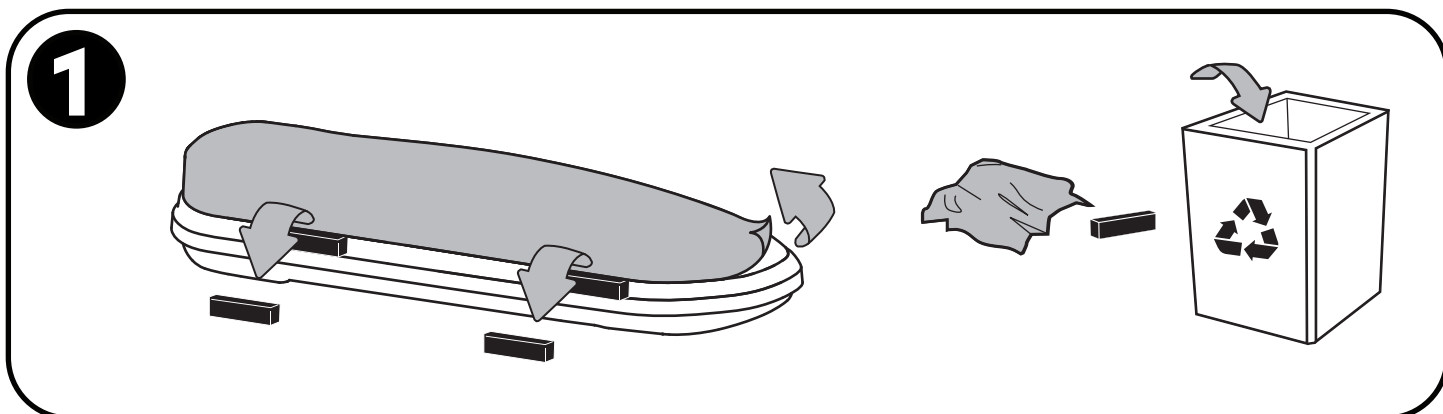

# 2

EasyTrip 400 - 40 cm MIN | 100 cm MAX  
EasyTrip 470 - 46 cm MIN | 115 cm MAX  
EasyTrip 550 - 50 cm MIN | 120 cm MAX

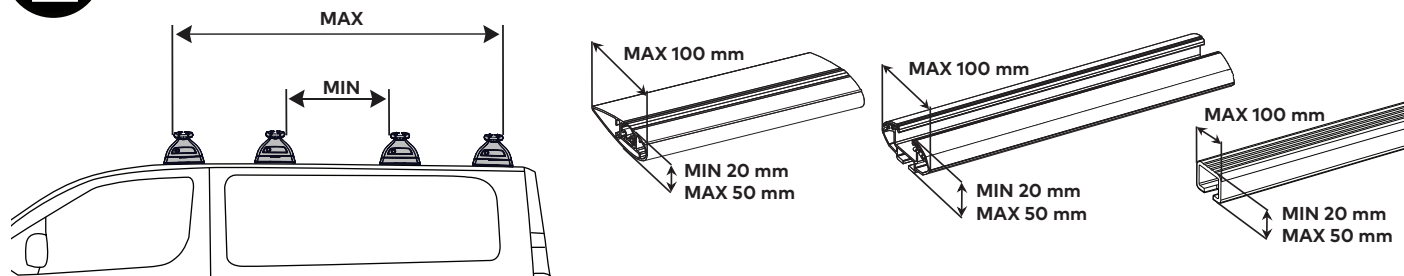

# 3

3.1

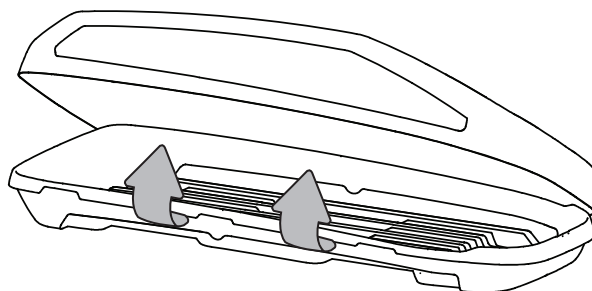
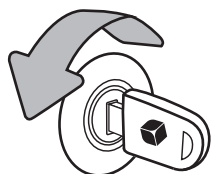

3.2

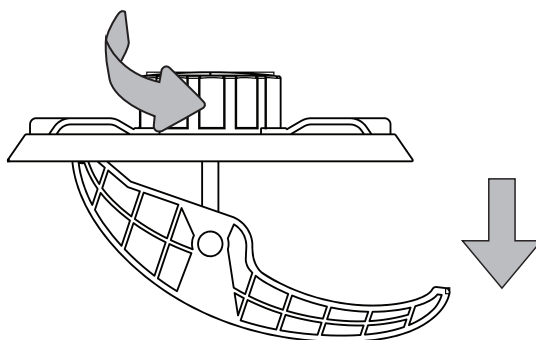

3.3

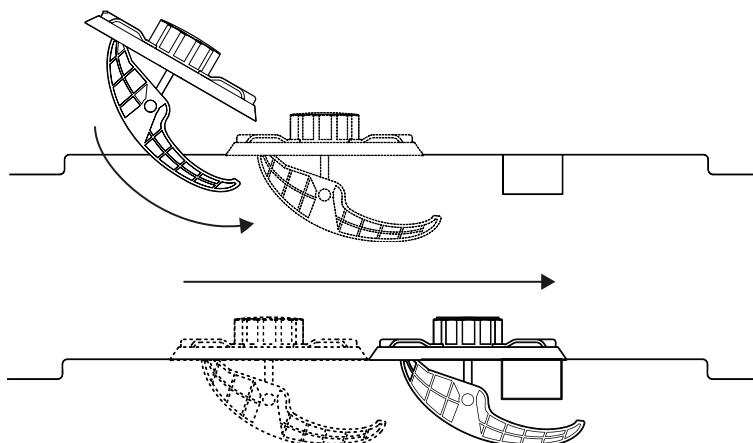

3.4

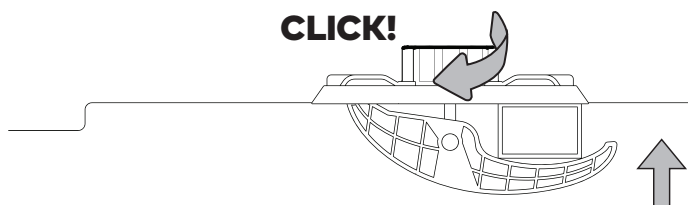

4

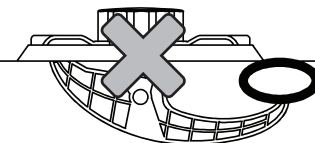
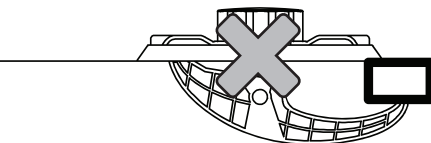
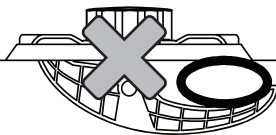
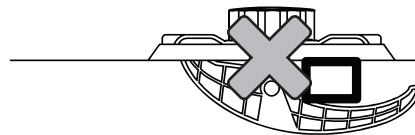
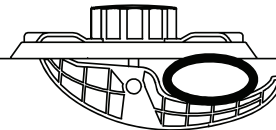
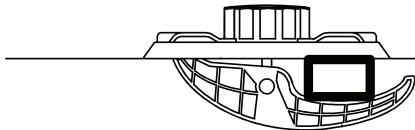
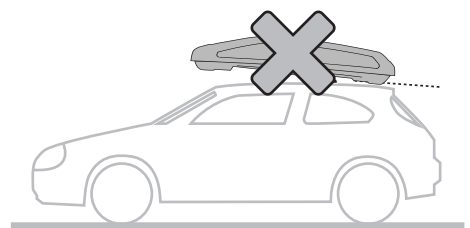
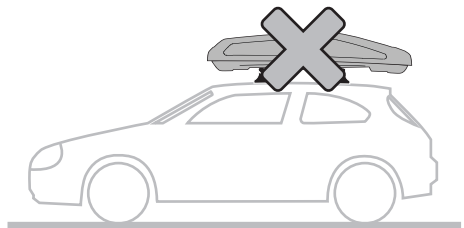
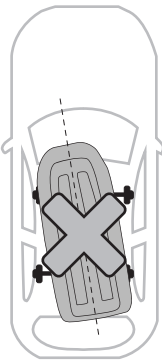
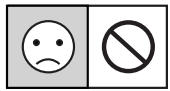
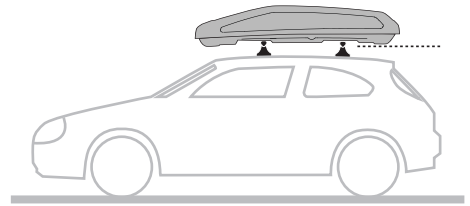
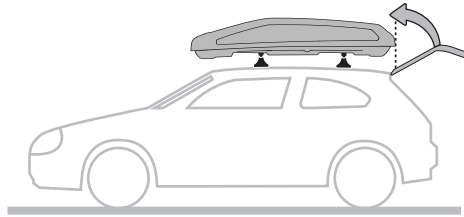
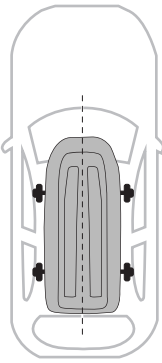
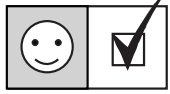

# 5

5.1

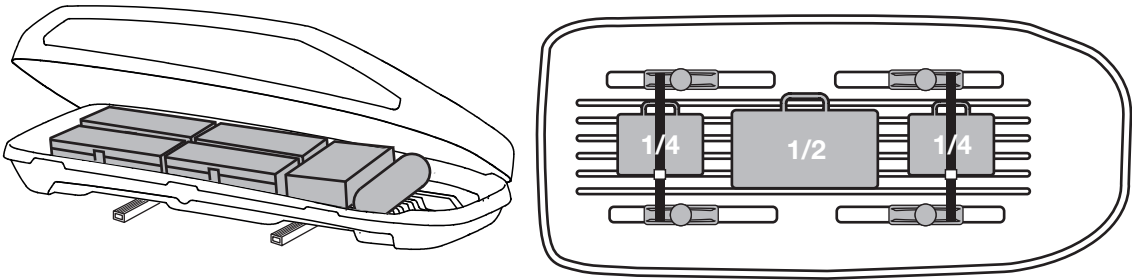

5.2

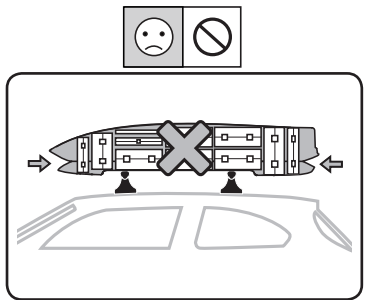
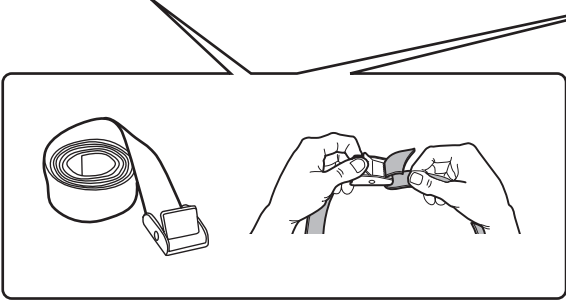
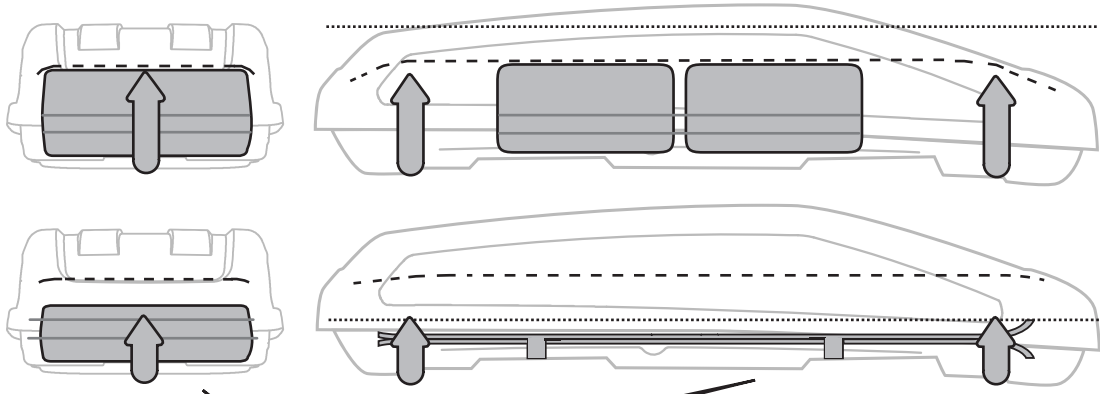

# 6

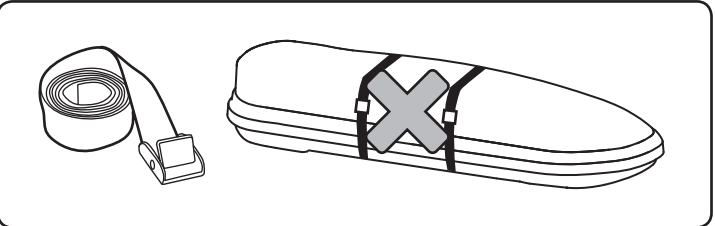
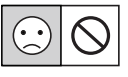
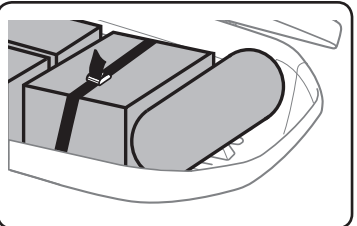
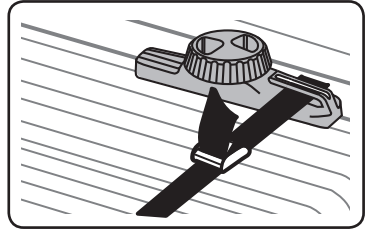
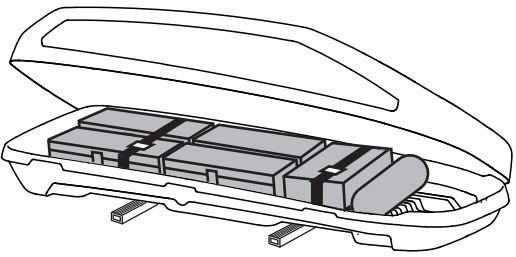

7

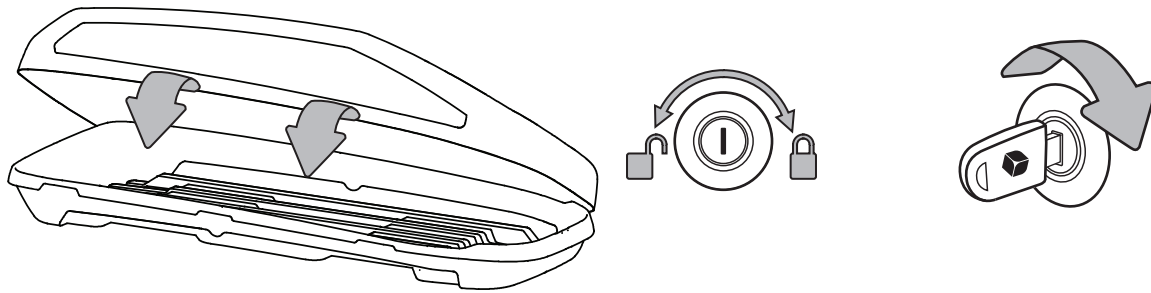

8



!

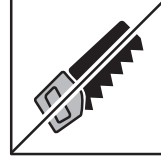
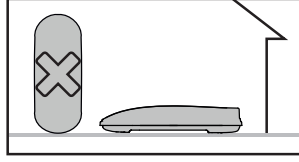
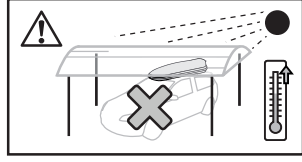
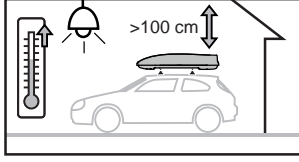
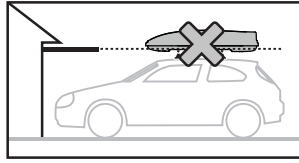
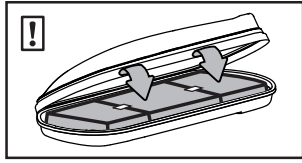
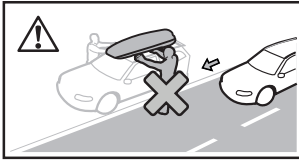
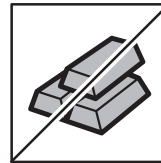
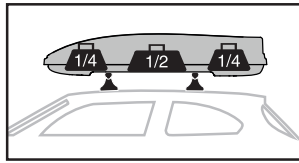
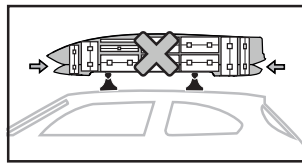
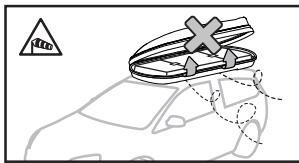
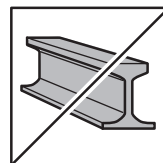
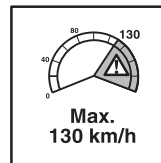
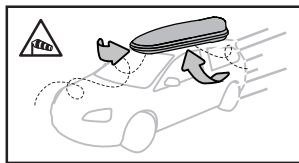
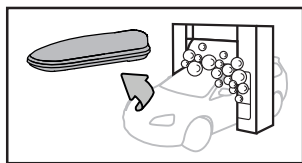
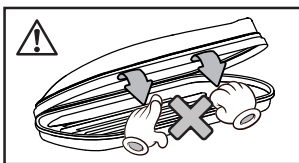
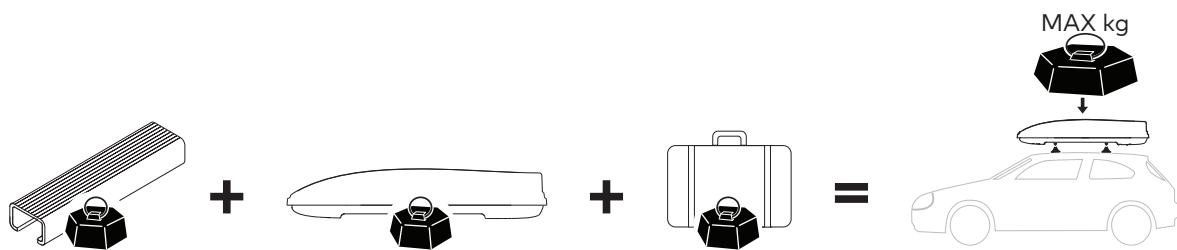



[www.yakima.com.au](http://www.yakima.com.au)  
[www.yakima.co.nz](http://www.yakima.co.nz)  
[www.yakima.com](http://www.yakima.com)  
[www.yakima.eu](http://www.yakima.eu)

**YAKIMA AUSTRALIA PTY LTD**

17 Hinkler Court  
Brendale, QLD 4500  
Australia  
1800 143 548  
[yakimaglobal.com](http://yakimaglobal.com)

**YAKIMA PRODUCTS, INC.**

4101 Kruse Way  
Lake Oswego, OR  
97035-2541  
USA  
888 925 4621  
[yakima.com/support](http://yakima.com/support)