

➤ Instructions

Thule RideAlong
100106, 100107, 100108



EN Child bike seat
DE Fahrradkindersitz
FR Siège vélo enfant
NL Fietszitje
IT Seggiolino da bici
ES Portabebés bici
PT Cadeira de criança para bicicleta
SV Cykelbarnstol
DK Cykelstol
NO Barnesete til sykkel
FI Polkupyörän lastenistuim
ET Jalgratta lasteiste
LV Velosipēda bērnu sēdekļis
LT Dviračio kėdutė vaikams
PL Fotelik rowerowy
RU Детское велосипедное сиденье
UK Дитяче велосипедне крісло
BG Детско столче за велосипед
CS Dětská cyklosedačka
SK Detská cyklosedačka
SL Otroški kolesarski sedež
HR/BIH Dječja sjedalica za bicikl

RO Scaun de copii pentru bicicletă
HU Kerékpáros gyerekülés
EL Παιδικό κάθισμα ποδηλάτου
TR Çocuk bisiklet koltuğu

HE כיסא אופניים לילד
AR مقعد دراجة الطفل

ZH 儿童自行车座椅
JA お子様用サイクルシート
KO 어린이 자전거 시트
TH เก้าอี้เด็กสำหรับจักรยาน



ASTM F1625-00

EN 14344:2004

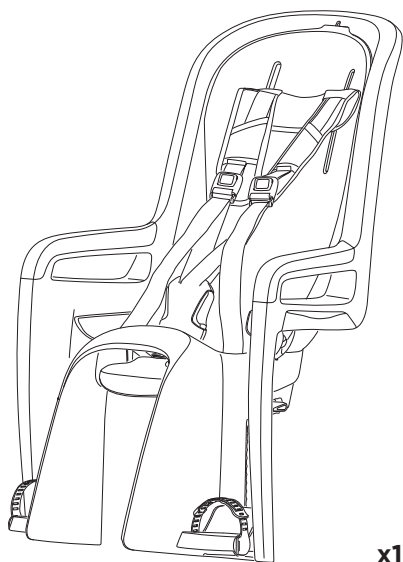
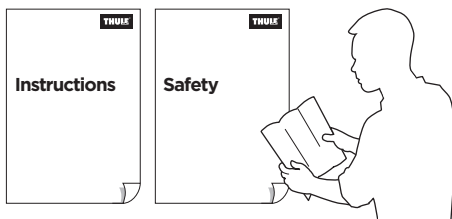

x1



x1

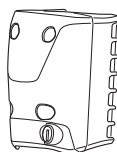

x1

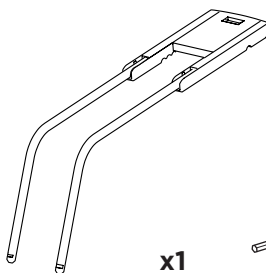

x1



x1



M6x44
M6x1.7"

x4



M6x58
M6x2.3"

x4

i



i



Europe & rest of the world	USA & Canada
9-72 M 9-22 kg 20-48,5 lbs	9-72 M 9-18 kg 20-40 lbs

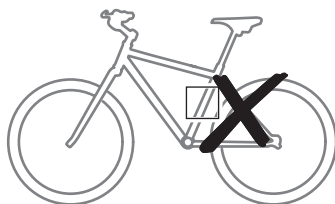
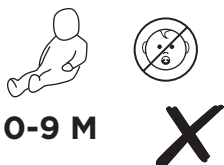

Carbon Fiber Frame

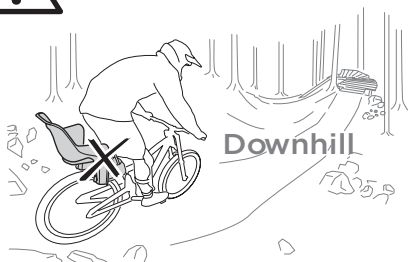

i

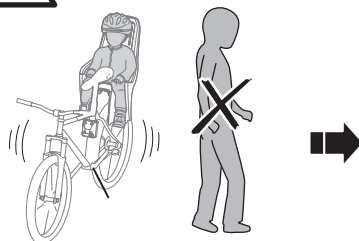
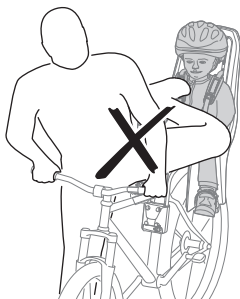
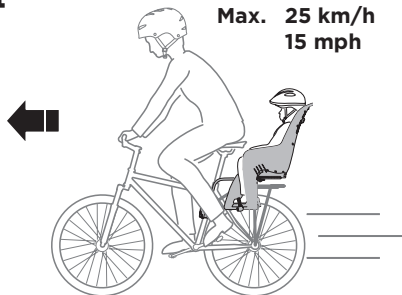

1

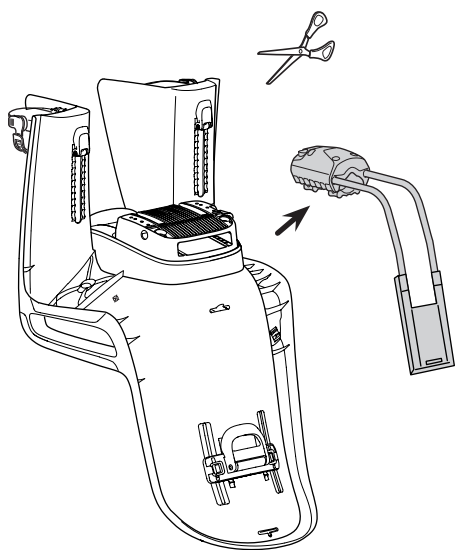

A

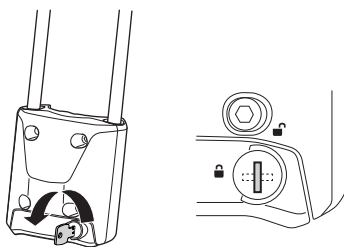

B

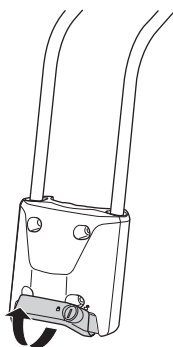

C

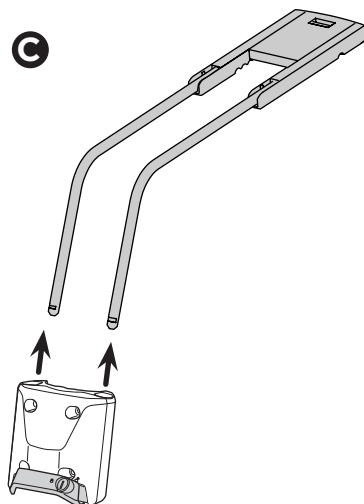

2

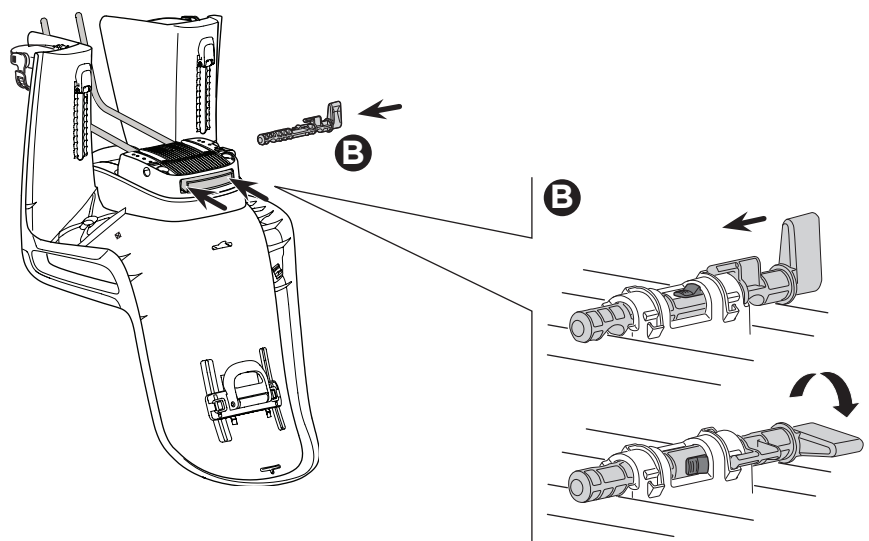
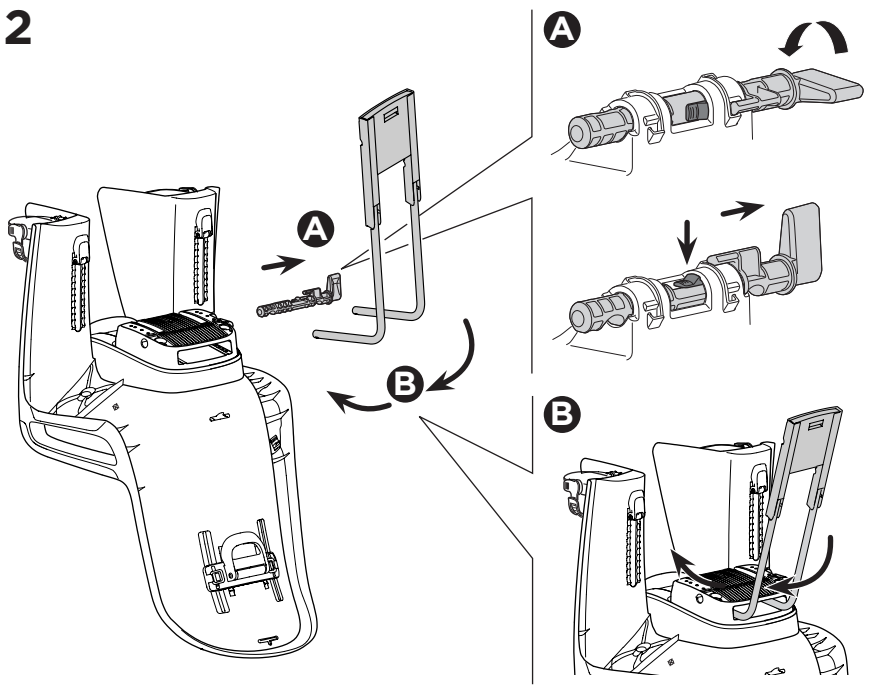

3

i

Ø 27.2-40 mm
Ø 1.07-1.57"

40x55 mm
1.57-2.16"

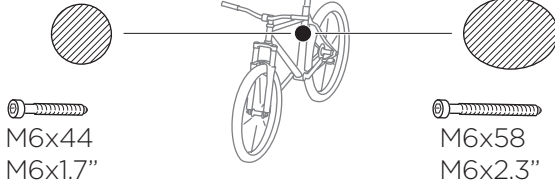

A

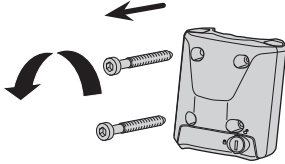

B

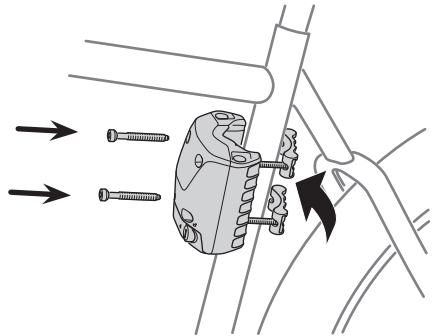

C

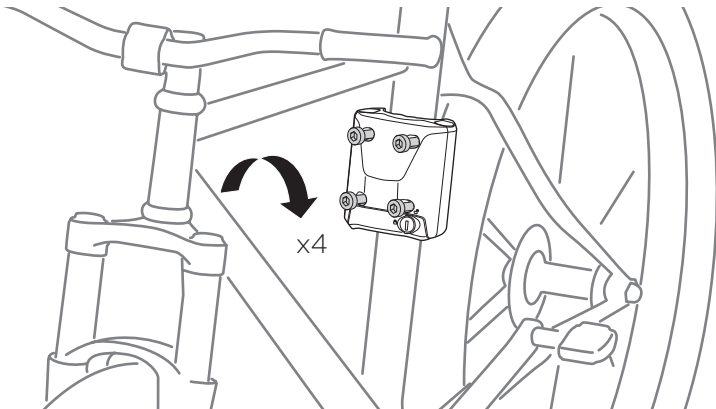

4

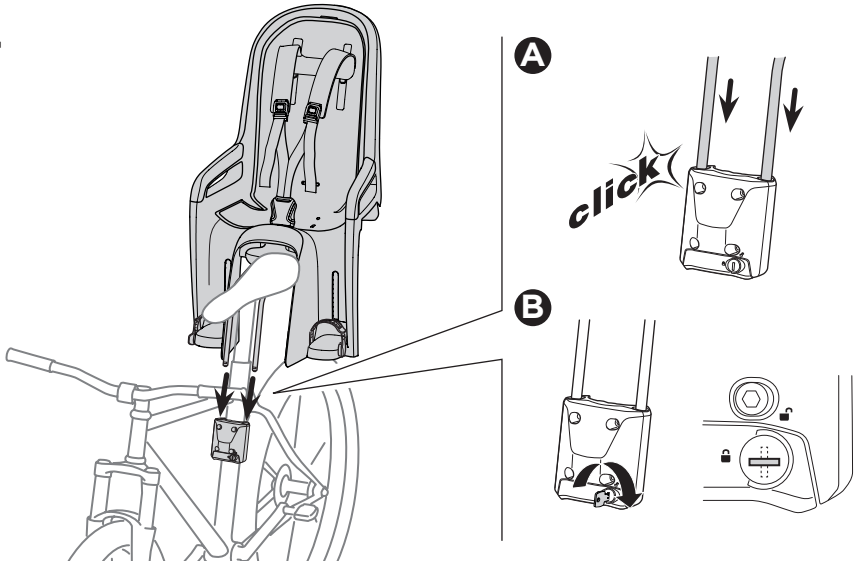

5

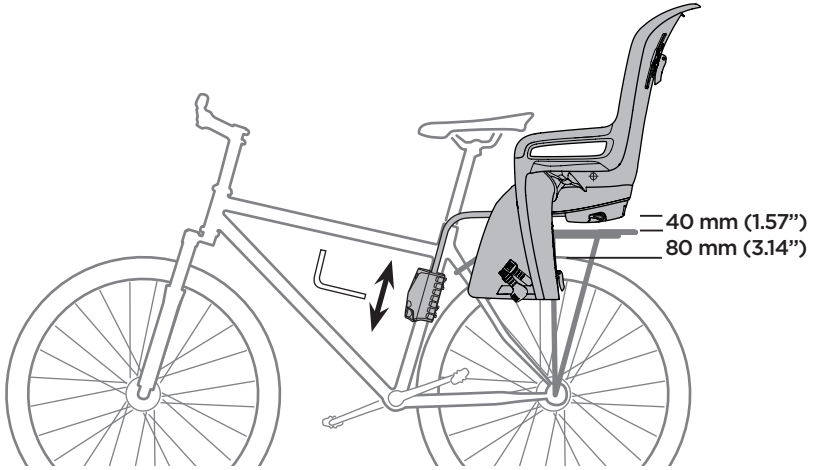

x4

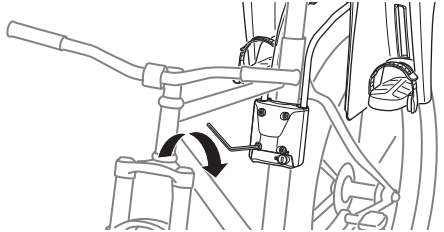

6

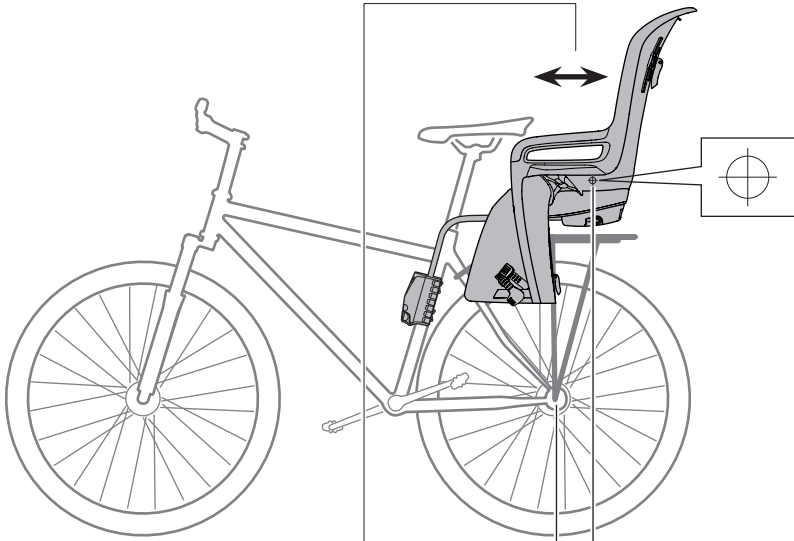
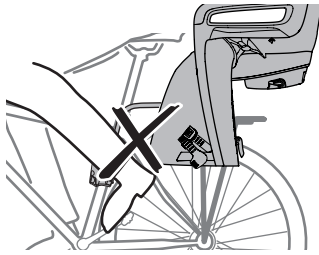

*max 100 mm
max (3.94")

*DE max 0 mm

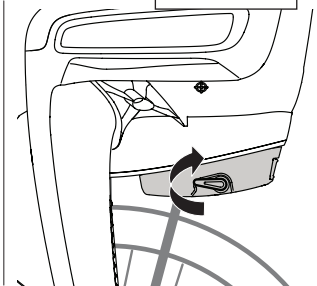
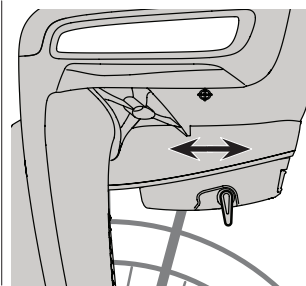
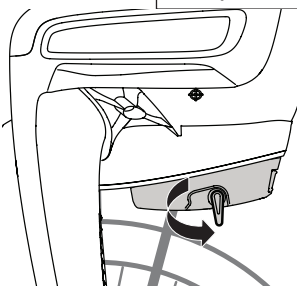
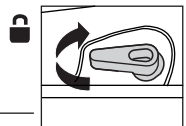
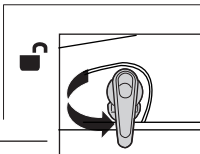

7

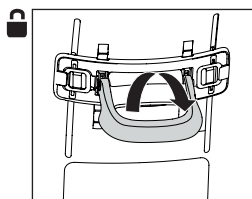
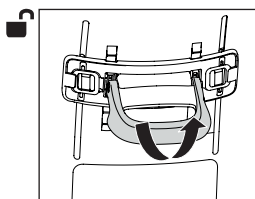
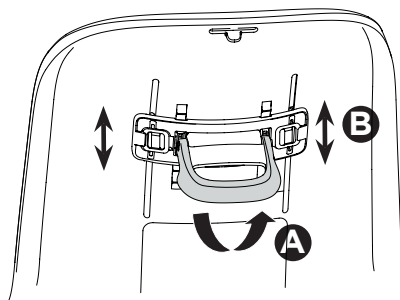
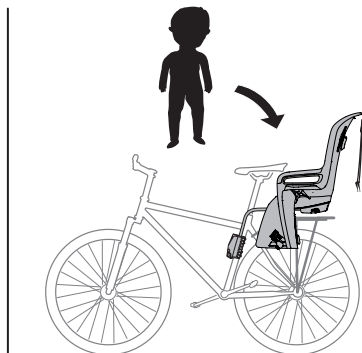
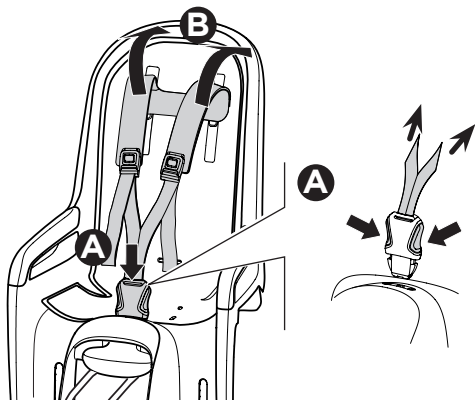

8

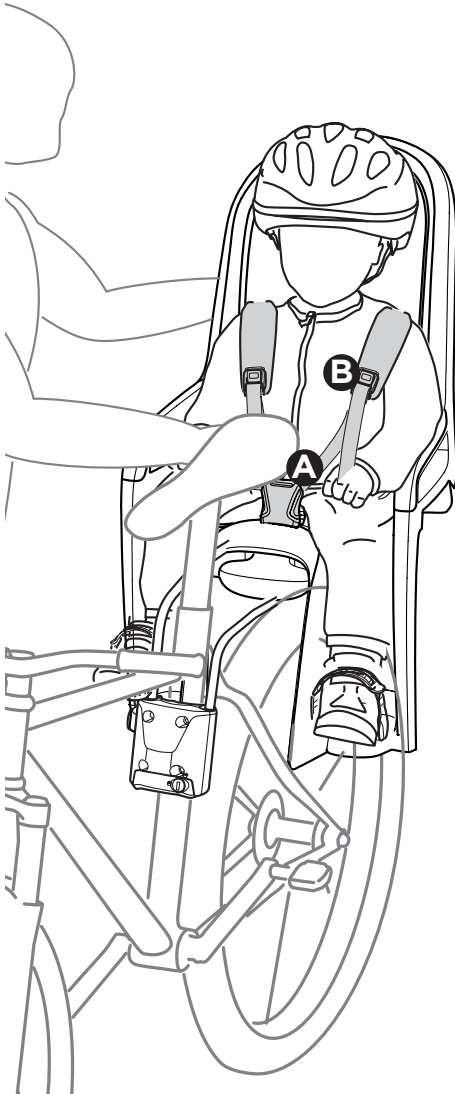

A

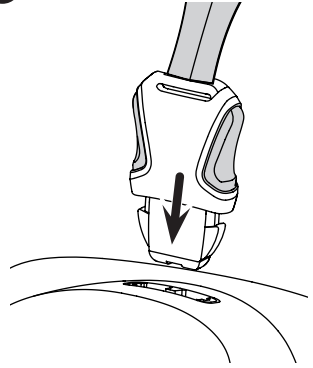

B

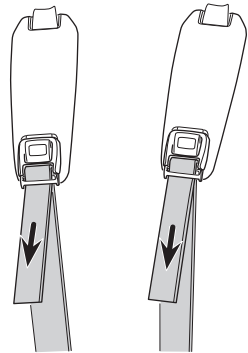

i

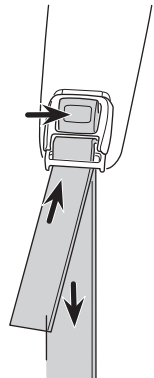

9

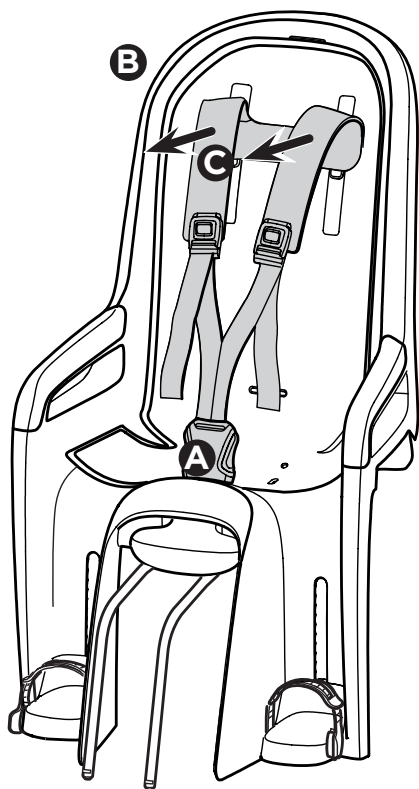

A

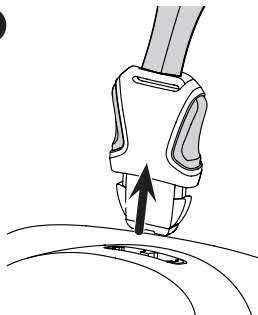

B

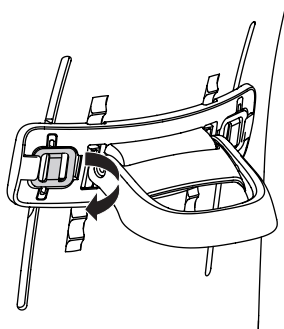

G

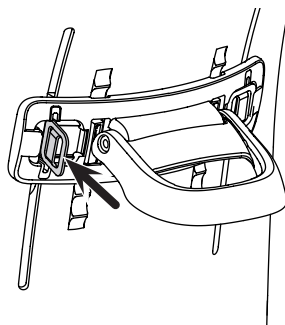

10

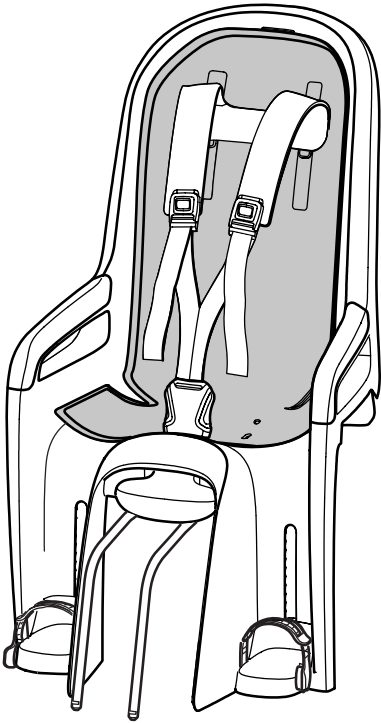

A

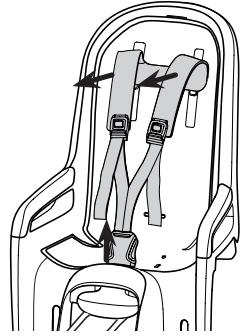

B

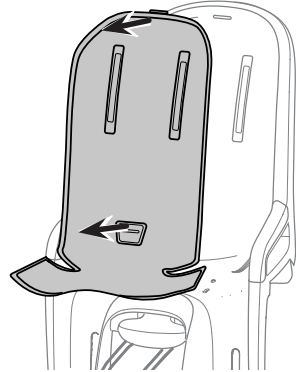

C

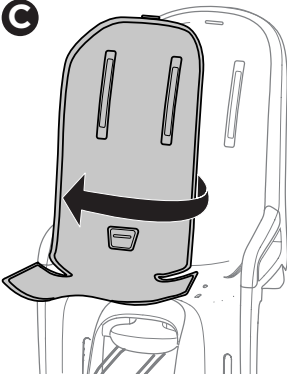

D

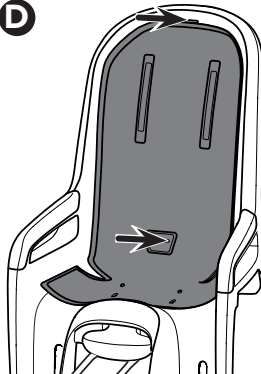

E

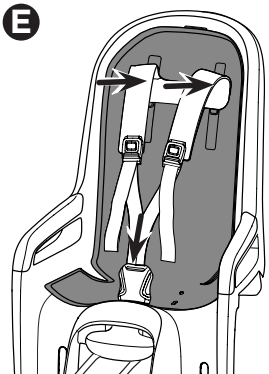

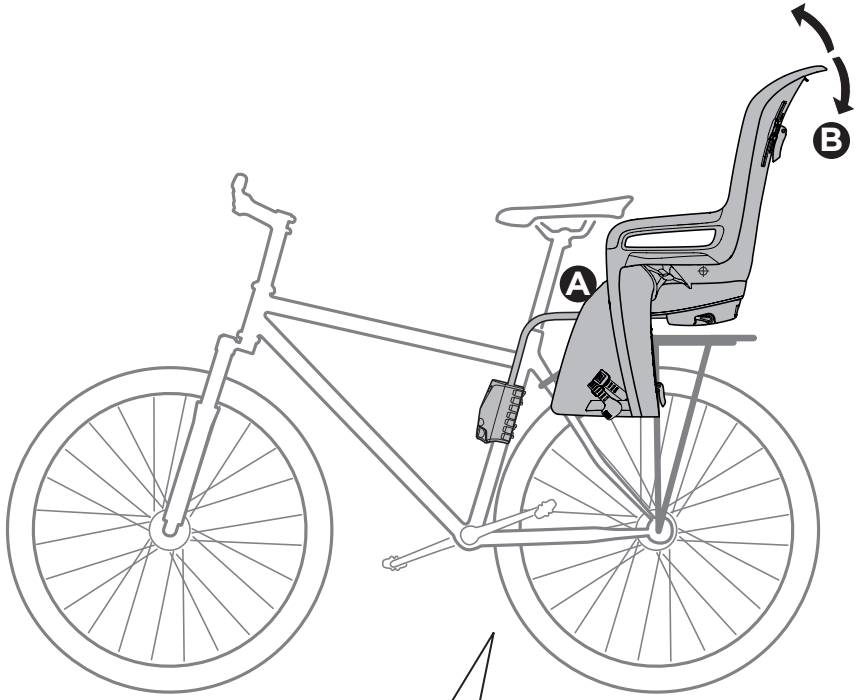

A



B

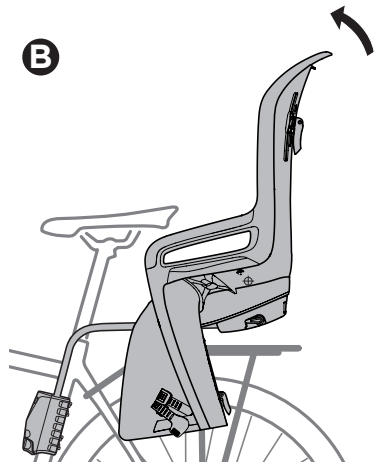

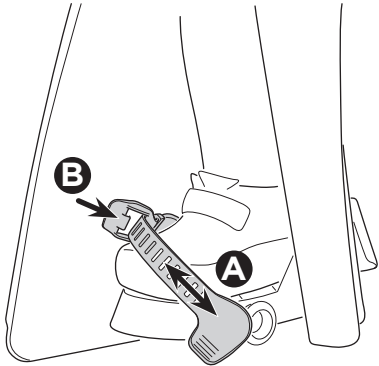
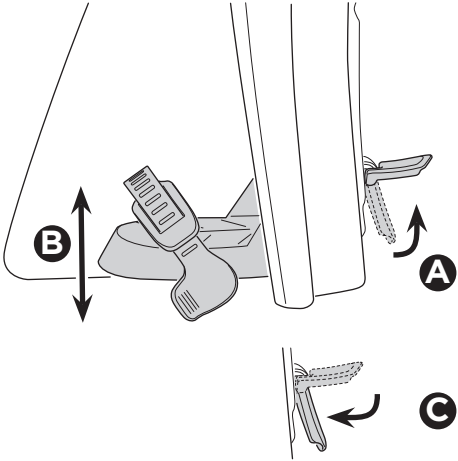
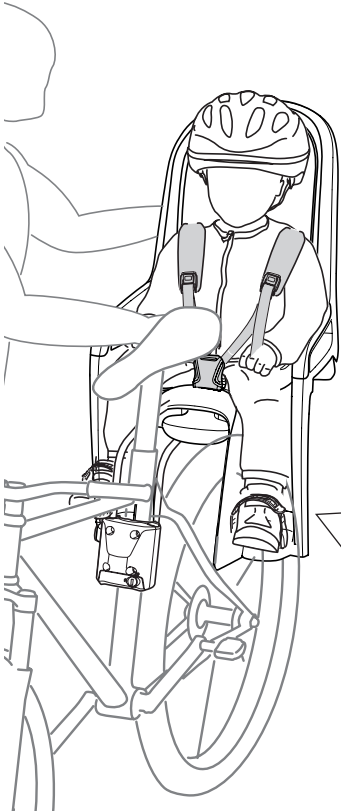

i



A



B

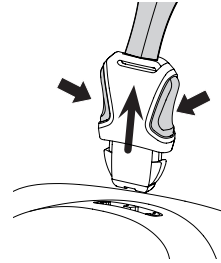

C

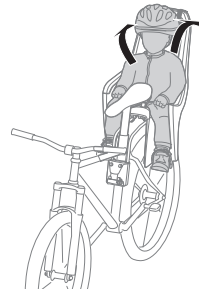

D

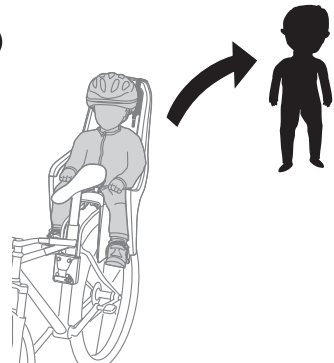

i

A

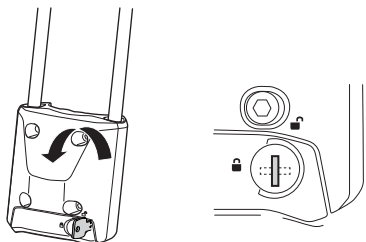

B

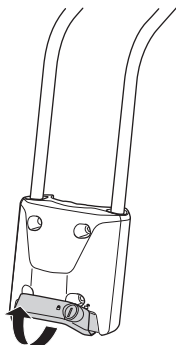

C

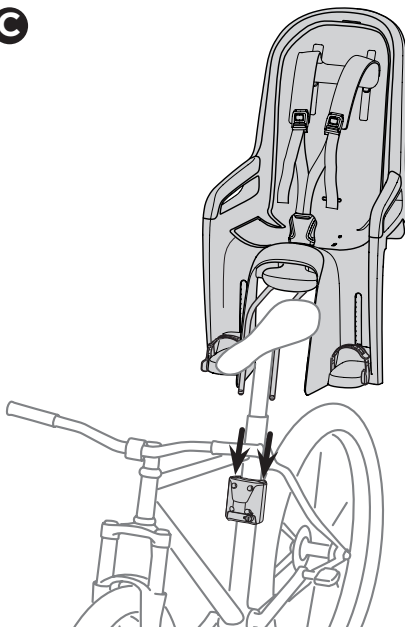

Thule One-Key System

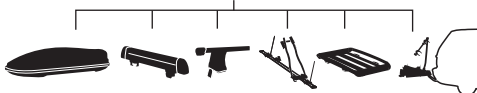

- 544**  (x4)
- 596**  (x6)
- 588**  (x8)
- 452**  (x12)

Thule Sweden AB, Borggatan 5, 335 73 Hillerstorp, SWEDEN
Thule Inc., 42 Silvermine Road, Seymour, Connecticut 06483, USA

info@thule.com
Phone: 800-238-2388

 www.thule.com